

“READY-TO-WEAR” VISUAL ENHANCEMENT KIT

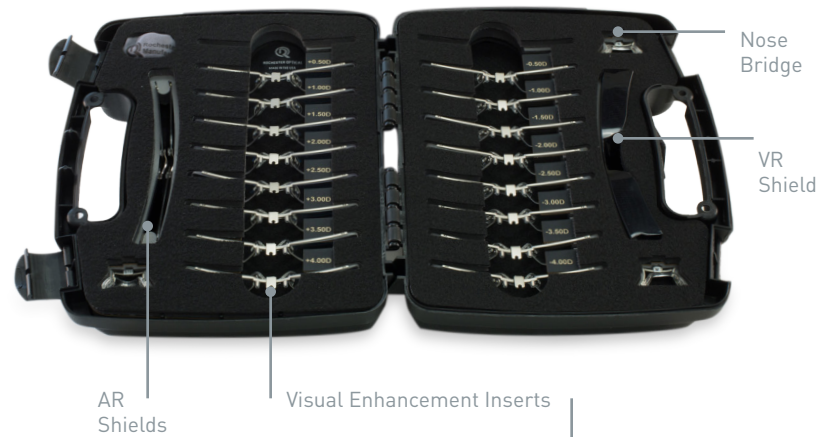

KIT INCLUDES:

- Sixteen Visual Enhancement Inserts
- Three Nose Bridge Sizes (Small, Medium, Standard)
- Two Mirror AR Shields
- One Matte Black VR Shield
- Compact Hard Shell Carrying Case



WARNING: The Rochester Optical Quick-Change Visual Enhancement Kit is intended to be used only with Epson® Moverio BT-200 Smart Glasses. User confirms and agrees to complete assembly in conformance with the enclosed instructions, and to the terms of sale and uses of this product. The Quick-Change Visual Enhancement inserts are not intended to replace user’s existing prescription eyewear, to provide user with vision correction or magnification, or to replace the need for regular eye exams. The inserts are intended for short term use for demonstrations, training or recreational activities as part of the Epson® Moverio BT-200 Smart Glasses only. Discontinue use immediately if you experience discomfort or dizziness. Not for use as protective eyewear. Handle and clean with care.

WARRANTY: Rochester Optical warrants to purchasers of its Quick-Change Visual Enhancement Kit that these products are free of material or workmanship defects for a period of one year from date of purchase. If the product is found defective in materials or workmanship and returned to Rochester Optical within the warranty period, then it will be replaced, with replacement constituting the sole remedy for breach of this warranty. Unless prohibited by applicable law, Rochester Optical disclaims all other expressed or implied warranties. This warranty does not apply to defects or damage arising from misuse, alteration, or improper assembly with Epson® Moverio BT-200 Smart Glasses, or assembly with any other type of eyeglasses or smart glasses for which the Quick-Change Visual Enhancement Kit is not designed to be used.



ROCHESTER OPTICAL VISUAL ENHANCEMENT KIT USER MANUAL

STEP 1

Remove screw that fastens factory rubber nose support.

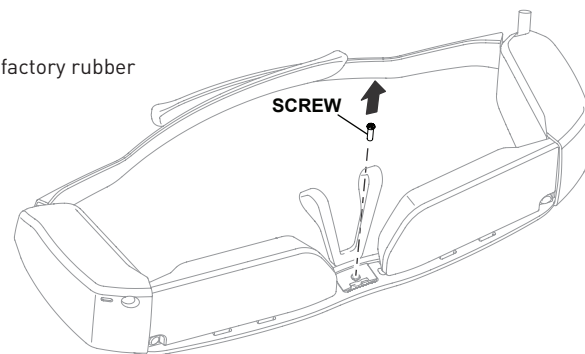

STEP 3

Re-install screw to the original location until seated, then turn screw back two complete revolutions.

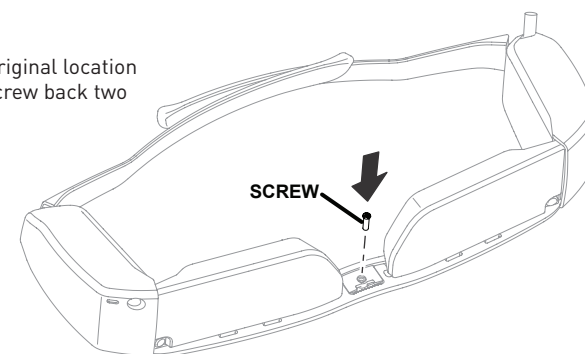

STEP 2

Remove factory rubber nose support by pulling it out slowly from the seat.

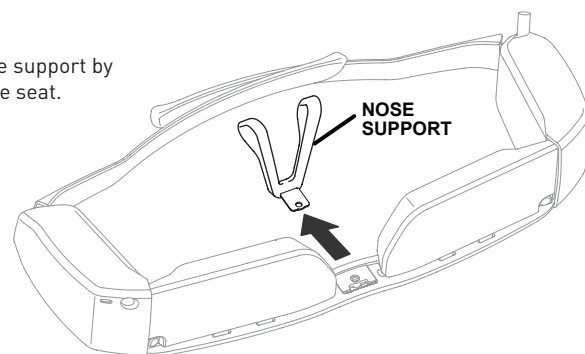

STEP 4

Insert quick-change nose bridge support from the VE Kit. Push in fully until seated.

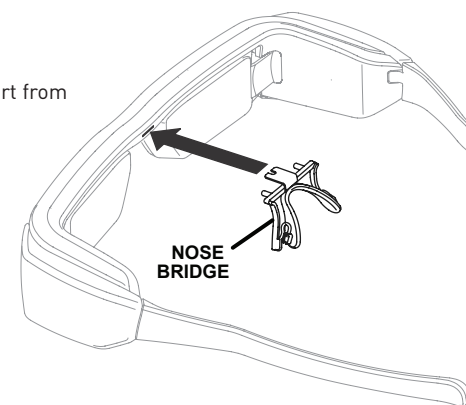
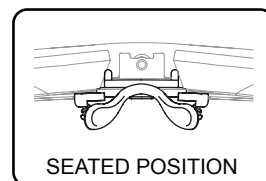

MAGNETIC AR SHIELD

AR shield magnetically* snaps to the front of the device.

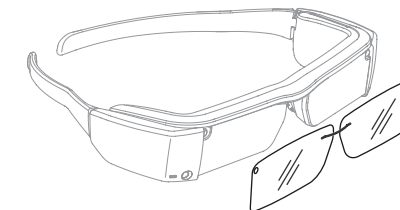

*Magnet Install Kit sold separately.

VR SHIELD

VR shield snaps to the front from the bottom. Push upward until shield snaps in place.

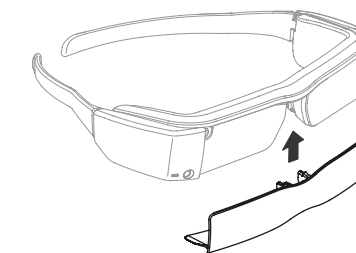

SILICON STRAP NOSE BRIDGE

The kit includes three silicon strap nose bridge sizes to fit any nose shape.

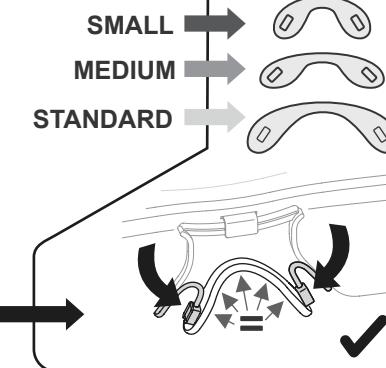
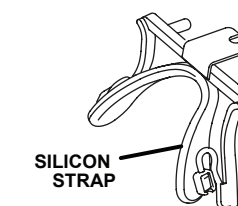

Adjust nose bridge to fit by bending the arms inward or outward.

HOW TO FIND THE SUITABLE ENHANCEMENT INSERT

- Ask the wearer if they know their correction.
- If they do, select the nearest power insert: minus powers, round up; plus powers, round down.

IF THE WEARER DOES NOT KNOW HIS/HER CORRECTION

- Identify if they have a plus or minus correction on their eyeglasses.
 - Plus corrections are thicker in the center.
 - Minus corrections are thicker at the edge.
- Look to match thickness of the eyeglass lenses to the VE insert options. Have wearer test by looking through.
- When you identify the appropriate power, mount insert into the BT-200.